

OWNER'S MANUAL

English

SERIES: **"EAGLE"**

MODELS: **E340 E380**

complete set: **E340, E340H***

E380, E380H*

Design category (2003/44/EC): C
ISO6185-3: Category VII

H* – boat tube is made of HYPALON (Du Pont registered trademark) coated fabrics.

CONTENTS:

DANGER LEVELS	5
INTRODUCTION	5
IDENTIFICATION PLATE	6
SAFETY REGULATIONS	7
BEAUFORT Wind Scale.	8
Boat Design Categories	8
REMEMBER FIRE DANGER ALWAYS	9
TECHNICAL SPECIFICATIONS	10
COMPLETE SET	11
BOAT DESIGN	12
RIGID HULL	14
REINFORCED BUOYANCY TUBE	15
STEERING CONSOLE	16
FUEL SYSTEM	18
DRAIN SYSTEM	20
WIRING DIAGRAM	22
STORAGE BATTERY INSTALLATION	23
INFLATION TUBE	23
BOAT TRAILERING	24
THE MAIN DIMENSIONS	25
MAINTENANCE	26
OPERATING REGULATIONS	27



For your safety and for the validity of the guarantee expert and authorised personnel must install the motor and inspect and check the systems. All onboard systems must be completed and inspected.

CHECK, THAT THE CHECKS HAVE BEEN MADE AND THAT THE PLANTS HAVE BEEN COMPLETED BEFORE DELIVERY.

BRIG Ltd declines any responsibility for systems and accessories that have not been installed and checked by expert and authorised personnel.



The manual and all its enclosures should be stored carefully, and the manual should always be kept aboard. If the craft is resold, the manual and all its enclosures must be handed over to the new owner.

CE Certification and Main Features

The CE marking indicates that the inflatable boat was built in compliance with the Directive 94/25/EC applied to pleasure craft

Certifying Body:

BUREAU VERITAS S.A.
92077 Paris La Defense Cedex

Name of Manufacture:

BRIG Ltd.
Lozovskaya 88, Dergachy 62303
Kharkovskaya obl.
UKRAINE
www.brig-ribs.ua

DANGER LEVELS.

The manual contains warnings, identified as follows:

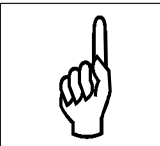
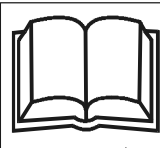
 DANGER	A note like this indicates that there is serious risk, that is likely to cause death or permanent serious injury, if appropriate precautions are not taken.
 WARNING	A note like this indicates the existence of risk that may cause death or injury, if appropriate precautions are not taken.
 ATTENTION	A note like this indicates reference to the application of safety or environmental protection practices, or draws attention to unsafe behaviour that might cause injury to persons or damage to the craft, its components or the environment.

INTRODUCTION.

This manual was written to help you to use your boat safely. It contains information on the boat, its equipment (supplied or installed), operation and maintenance.

 DANGER	Before using your boat, read this MANUAL carefully and ensure that you have understood all the procedures it describes. Before taking command of your boat, be sure to have acquired experience and confidence in its operation.
--	--

IDENTIFICATION PLATE.









Builder's Plate:









E340

E380

Maximum propulsion power rating for the boat

The rated tube pressure value

  	
Notified Body No.0062 Conforms to ISO 6185	
Type VII	
MODEL E340	DESIGN CATEGORY C
 < 26 kW 35 HP	 < 4
 +  +  ≤ 495 kg 1092 lbs	
 0.15 bar (2.2 psi)	Made in UKRAINE

  	
Notified Body No.0062 Conforms to ISO 6185	
Type VII	
MODEL E380	DESIGN CATEGORY C
 < 37 kW 50 HP	 < 5
 +  +  ≤ 555 kg 1224 lbs	
 0.15 bar (2.2 psi)	Made in UKRAINE

Boat Design Categories according to Directive 2003/44/EC

Passengers capacity

Maximum total load (ML)

Plate with identification number:

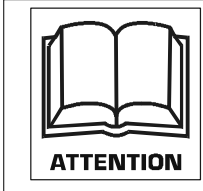

UA-QRK12345A000



It is fundamental for the plates to be aboard the boat, since they are only form of recognition and identification. Without them the boat does not comply with the legislation in effect. The plates must never be removed. Any tampering or removal not authorised by the manufacturer is the full responsibility of the owner.

SAFETY REGULATIONS.

This manual contains recommendations and basic rules of conduct for using the boat in complete safety. Although it is not possible to offer safety information for all potential situations, in general it is recommended that you :

	Regularly check which safety requirements are in force.
	Maintain the boat and the onboard plants in optimum condition.
	Have the boat inspected by the dealer where it was purchased or by an authorised mechanic at least once every year for your own safety and for maintaining the guarantee.
	Always check weather and seagoing conditions before setting out. For safe navigation, compare the design category of your boat with the table below.
	When the tank is installed by the yard, the plant is prepared with a ground plait. The installation of the motor MUST FORESEE A PLAIN CONNECTION to the boat ground plait. Failure to connect (or failed maintenance) can result in the tank perforating leading to a serious risk of fire / explosion caused by leaking fuel.
	Max number of transportable persones is referred to an established weight of 75 kg per person (ISO 6185), so always make reference to total maximum transportable weight. The max weight of the installable motors indicates the maximum overall weight applicable on the stern board, including any emergency motors. NEVER exceed the stated value.

BEAUFORT Wind Scale and Corresponding State of the Sea, After Few Hours of Wind, Away From the Coast.

Force	Denomination	Knots	Km/h	m/sec	State of the sea and wave height in meters	
0	Calm	<1	<1	0-0.2	Calm	0
1	Light Air	1-3	1-5	0.3-1.5	Calm	0
2	Light Breeze	4-6	6-11	1.6-3.3	Almost calm	0.2
3	Gentle Breeze	7-10	12-19	3.4-5.4	Almost calm	0.2
4	Moderate Breeze	11-16	20-28	5.5-7.9	Small waves	0.5
5	Strong Breeze	17-21	29-38	8.0-10.7	Large waves	1.25
6	Fresh Wind	22-27	39-49	10.8-13.8	Large waves	2.0
7	Strong Wind	28-33	50-61	13.9-17.1	Very large waves	2.5
8	Gale	34-40	62-74	17.2-20.7	Rough sea	4
9	Strong Gale	41-47	75-88	20.8-24.4	Very rough sea	6
10	Storm	48-55	89-102	24.5-28.4	Heavy	9
11	Violent Storm	56-63	103-117	28.5-32.6	Very heavy	14
12	Hurricane	64 and over	118 and over	32.7 and over	Stormy	14 and over

Boat Design Categories (Directive 2003/44/EC):

Design category	Wind force (Beaufort scale)	Significant wave height
"A" - "Ocean"	exceeding 8	exceeding 4
"B"- "Offshore"	up to, and including, 8	up to, and including, 4
"C"- "Inshore"	up to, and including, 6	up to, and including, 2
"D"- "Sheltered waters"	up to, and including, 4	up to, and including, 0.3

NOTE: **The significant wave height** is the mean height of the highest one-third of the waves, which approximately corresponds to the wave height estimated by an experienced observer. Some waves will be double this height.

ALWAYS REMEMBER ABOUT FIRE DANGER.

Fire may be caused by:

Crew negligence when smoking, the presence aboard of flammable liquids, electrical contacts, propulsion motor, errors in fueling, or if maintenance has not been performed as required.

Once again, it is important that the crew behave correctly and that the boat is kept in order to avoid serious damage to it and to persons.

	Easily flammable products must not be kept aboard.
---	--

	BATTERY: the battery may cause sparks or explosions. It must be stored in an appropriate container, easily reached and well aired, AWAY FROM FUEL OR INFLAMMABLE PRODUCTS. Periodically check that the clips are tight and protect them with appropriate insulation in order to prevent sparks or the spread of current.
---	--

However, if a fire does occur aboard, stop motor, disconnect the batteries immediately, check to see if it is an electrical component or any case a small-scale fire that does not involve flammable liquids, in which case use a suitable fire extinguisher to try and put the fire out completely.

	Extinguisher or any other fire-fighting equipment must not be kept in compartments with key lock, but in easily accessible and clearly indicated locations.
	Extinguisher or any other fire-fighting equipment should be checked periodically and replaced with the same or superior types if expired or inefficient.

	Equip the boat with fire-fighting equipment before launch and use.
--	--

TECHNICAL SPECIFICATIONS.

The basic parameters and dimensions of the boats E340 (E340H) and E380 (E3800H) comply with the data specified in the following table. All dimensions measurements indicated have a tolerance of +/- 3%, weight measurements indicated have a tolerance of +/- 5%.

Parameter	E340 (E340H)	E380 (E380H)
Length (without engine)	3.40 m	3.83 m
Width	1.78 m	1.93 m
Height (without engine)	1.12 m	1.15 m
Inflatable tube diameter, max.	0.46 m	0.46 m
Cockpit dimensions:		
- length	2.09 m	2.43 m
- width	0.83 m	0.84 m
Deadrise angle on transom	16°	18°
Deadrise angle in middle section	18.5°	19°
Transom height	500mm	500mm
Number of independent air-tight chambers	3	3
Nominal air pressure in the tube	0.15bar / 2.2 psi	0.15bar / 2.2 psi
Passengers capacity	4	5
Recommended engine power	25HP / 18.4kW	40HP / 29.4kW
Maximum engine power*	35HP / 25.7kW	50HP / 36.7kW
Maximum engine weight	100kg	120kg
Engine shaft length	20" (Long)	20" (Long)
Built-in fuel tank capacity	33L	43L
Weight of empty boat (without fuel and engine)	180kg	210kg
Maximum load capacity of empty boat(ISO method)	600kg	700kg
Displacement in Light Craft Condition (LCC)	285kg	355kg
Maximum total load (ML)	485kg	555kg
Maximum transportable mass	480kg	535kg
Loaded displacement mass	780kg	910kg

* When the boat is fitted with an engine with maximum recommended power it must be use with extreme care. This application is directed at experienced users using their boats for very specific purposes.

COMPLETESET.

In the table shows the maximum possible complete set, which may differ from your boat.

No	Description	Unit	E340	E380
1	Inflatable boat	pcs.	1	1
2	Foot pump	pcs.	1	1
3	Paddle	pcs.	2	2
	Set of spare parts and repair kit:			
4	- mooring line	m	18	18
5	- fabric for repair	m ²	0.06	0.06
6	- glue set for repair	set	1	1
7	Bag	pcs.	1	1
8	User's manual	pcs.	1	1
9	Fuel tank	pcs.	1 (33L)	1 (43L)
	Steering console:			
10	Steering system	pcs.	1	1
11	Steering wheel	pcs.	1	1
12	Steering cable	pcs.	1	1
	Console installation kit:			
13	Analog fuel clock	pcs.	1	1
14	Switches of electrical equipment	pcs.	3	3
15	Speedometer	pcs.	1	1
16	Tachometer	pcs.	1	1
17	Cigarette lighter	pcs.	1	1
18	Front locker removable cursion	pcs.	1	1
19	Side removable cursion	pcs.	1	1
20	Masthead light (white)	pcs.	1	1
	Bow removable sundeck:			
21	Sundeck floor board	pcs.	-	1
22	Sundeck cursion	pcs.	-	1
23	Battery container	pcs.	1	1
24	Battery disconnecter	pcs.	1	1
25	Drain automatic bilge pump	pcs.	1	1
26	Overall cover	pcs.	1	1
	Additional options:			
27	Valve cap pressure gauge	pcs.	1	1
28	Lifting slings set	set	1	1

Note. Perfection of the design and improvement of quality of our products is the fundamental production policy of our company. Therefore, alternations may be made to the complete set (and as the components become available).

BOAT DESIGN.

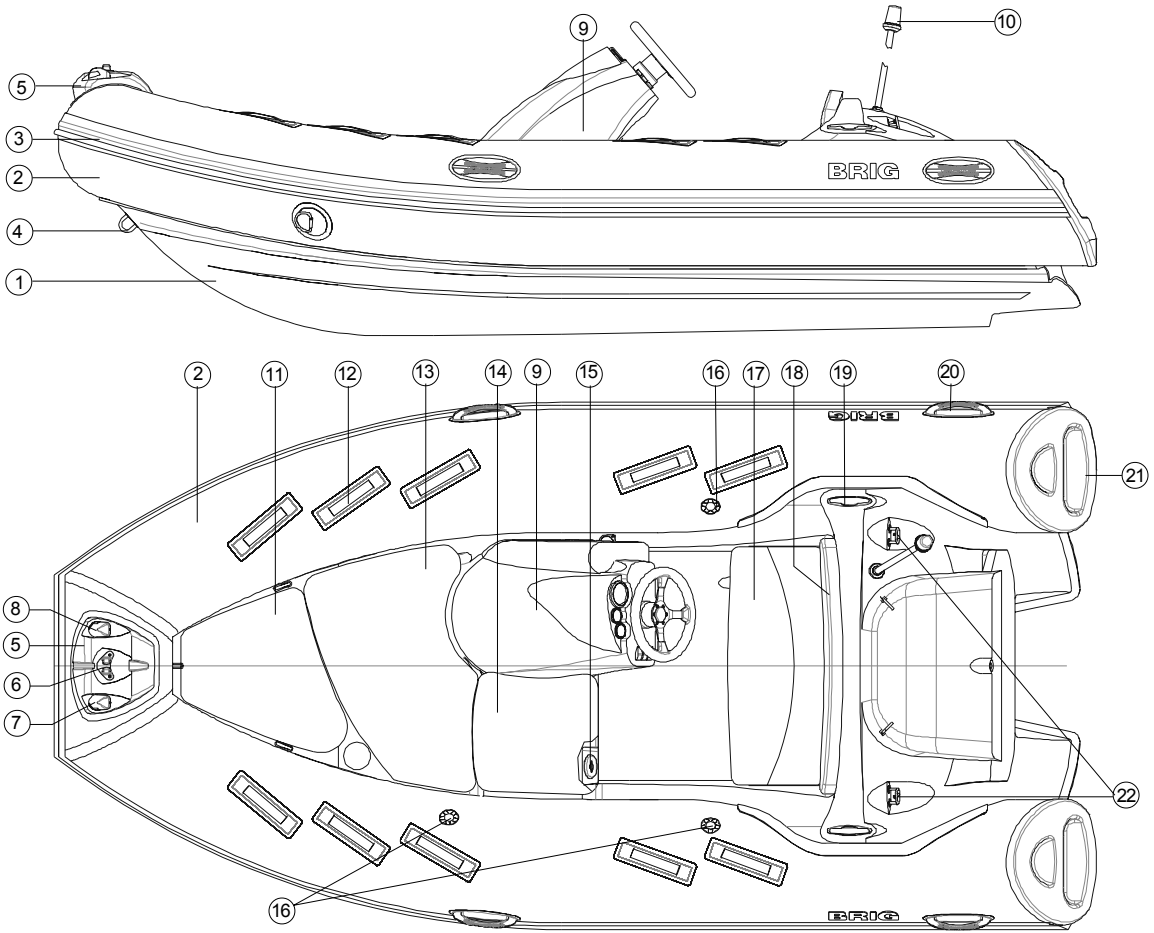

DESCRIPTION:

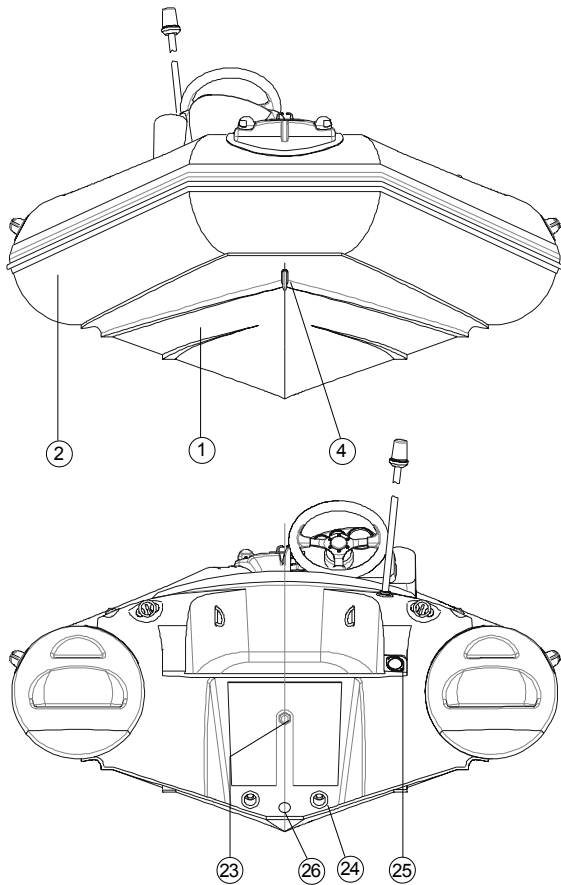

- 1 — Fiberglass plastic hull.
- 2 — Reinforced buoyancy tube.
- 3 — Rubbing strake.
- 4 — Towing bow eye.
- 5 — Bow fiberglass plastic plate.
- 6 — Semi-hawse.
- 7 — Port navigation light (red).
- 8 — Starboard navigation light (green).
- 9 — Steering console.
- 10 — Masthead navigation light (white).
- 11 — Bow locker removable cursorion.
- 12 — Safety handles.
- 13 — Bow removable sundeck.
- 14 — Side removable cursorion.
- 15 — Fuel fill.
- 16 — Air fill valve (3 pcs.).
- 17 — Stern seat.
- 18 — Soft back of stern seat.
- 19 — Mooring cleat (2 pcs.).
- 20 — Carrying handles (4 pcs.).
- 21 — Fiberglass plastic end of the tube.
- 22 — Watersci towing eyes (2 pcs.).
- 23 — Thru-hull (engine recess drain system).
- 24 — Cockpit drain system socket (2 pcs.).
- 25 — Outlet for steering system cable.
- 26 — Bilge valve.

Fig.D1

RIGID HULL.

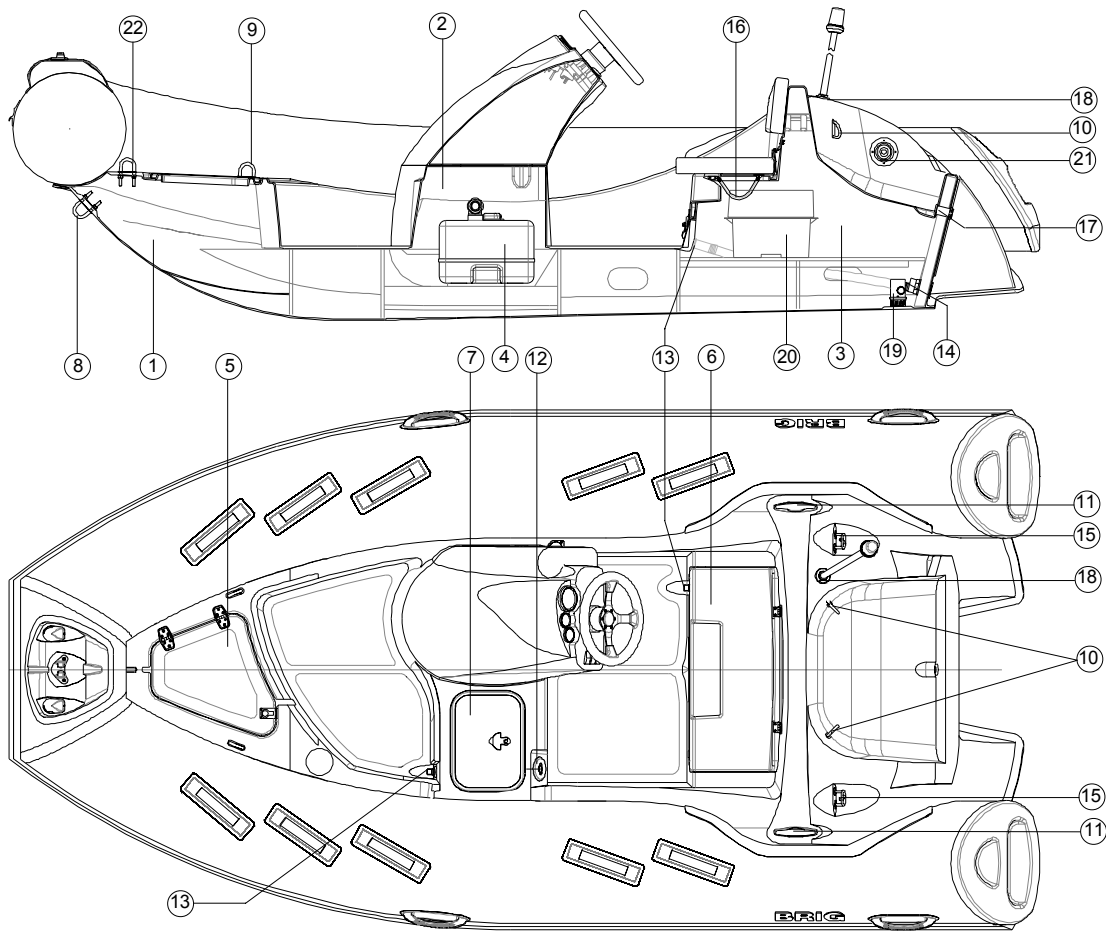

Fig.D2

"BRIG" inflatable boats

The boat hull has increased deadrise with two longitudinal steps. The upper deck surface has a special moulded antiskid coating. There are three specified sections (Fig. D2) :

- bow locker (1);
- deck locker (2) is intended for arrangement of the fuel tank (4);
- stern locker (3).

The bow locker and stern locker have a direct access by hinge out the access doors (respectively 5 and 6 positions). There is fire extinguisher recess, formed in the stern locker access door. For better access into the deck locker the hatch (7) has been mounted. Onto the bow locker there is a removable soft cushion (11, Fig.D1). Onto the stern locker there are soft seat (17, Fig.D1) with soft back (18, Fig.D1).

The boat hull is arranged with the following components:

- bow towing eye (8);
- two bow lifting eye (9);
- two stern lifting eyes (10);
- two stern mooring cleats (11);
- fuel tank (33L for E340 or 43L for E380) (4);
- fuel fill (12);
- two cockpit drain system sockets with waterproof plugs (13);
- two cockpit drain system sockets with flexible diaphragms (14);
- two waterski towing eyes (15);
- spring support for stern locker seat (16);
- thru-hull of the engine recess drain system (17);
- socket for mounting masthead light rod (18);
- drain automatic bilge pump of the hull drain system (19);
- thru-hull of the hull drain system (hasn't shown on the figure);
- battery disconnect (hasn't shown on the figure);
- anchor rope "U"-shaped bolt (22).

It is possible to install the rigid sundeck board with the soft sundeck cushion from the complete set in the bow part of the deck (13, Fig.D1).

It is possible to mount the battery container from the complete set in the stern locker (20). The outlet with splashproof ring in the engine recess is provided for remote control cables (21).

Series "EAGLE" E340 E380

REINFORCED BUOYANCY TUBE.

The boat buoyancy tube has U-shaped form. The tube is separated by means of inner elastic partitions into five chambers of a similar volume, each being provided with an air fill valve.

The air fill valve is intended for:

- filling the compartment with air from a standard pump or filling system and maintaining pressure in the tube for prolonged time,
- adjustable drop of pressure in compartment.

The air fill valve is designed as a tab-type non-return valve and consists of the following components (Fig. D3):

- housing (1);
- cup (2) with strap (3);
- washer with gasket (4);
- nut (5);
- spindle (6) with spring (7) and cup diaphragm (8).

Also there are the following elements fitted on the tube (Fig. D1):

- rubbing strake (3);
- handles (12, 20);
- bow fiberglass plastic plate (5) with semi-hawse (6) and navigation lights (7, 8);
- two fiberglass plastic ends of the tube (21) with two antiskid steps each.

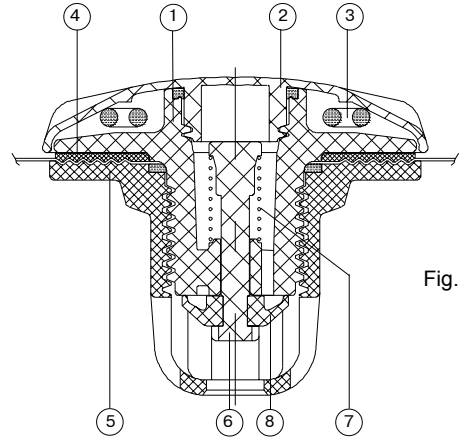

Fig.D3

STEERING CONSOLE.

Fiberglass plastic steering console is intended for plasing steering system, remote controle box, electrical equipment. The console is located on the starboard of the boat deck. The console consists of the following components (Fig.D4):

- lower console part (1), integrated into the boat deck;
- moveable overhead part (2), hinged with the lower part and fixed by means of three nuts with washers and arrester washers.

Inner compartment of the lower part of the console is provided for plasing plastic fuel tank. On the port side of the lower part of the console there is the fuei fill (3) and waterproof inspection hatch (4).

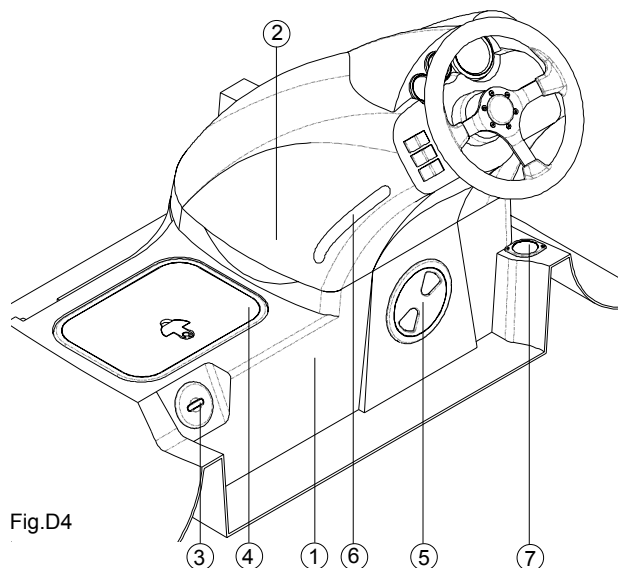
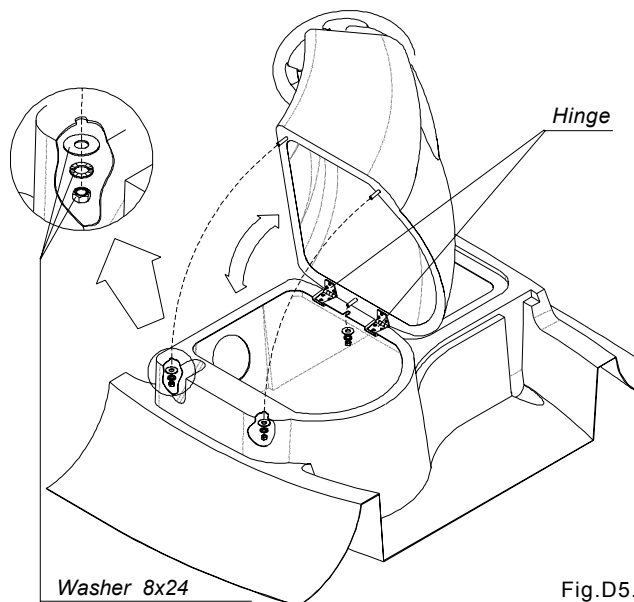

Fig.D4



Washer 8x24

Arrester washer 8

Nut M8

Fig.D5.

Round waterproof hatch (5) on the starboard of the console lower part is intended to have access to fastening nuts and washers fixing console overhead part (2) with the lower part (1). Stainless steel handle (6) is mounted on the console overhead part. Outlet (7) for remote control cables is located starboard near the console lower part.

In order to have access to the inner part of the steering console when mounting steering system, remote control box, additional electrical equipment, etc. it is necessary:

- open covers of the hatches (4) and (5), (Fig.D4);
- turn off three nuts M8 with washers 8x24 and arrester washers 8, (Fig.D5);
- hing up the overhead part of the console, (Fig.D5).

Before the exploitation of the boat hing down the overhead part of the steering console and fix it to the lower part with the help of three nuts M8 with washers 8x24 and arrester washers 8 (Fig.D5).

Console equipment (Fig. D6):

- steering system;
- steering system cable;
- steering wheel (1);
- analog fuel clock (2);
- speedometer (3);
- tachometer (4);
- switches and fuses:
 - navigation lights and meter lamp switch (5);
 - hull drain pump switch (6);
 - masthead light switch (7).

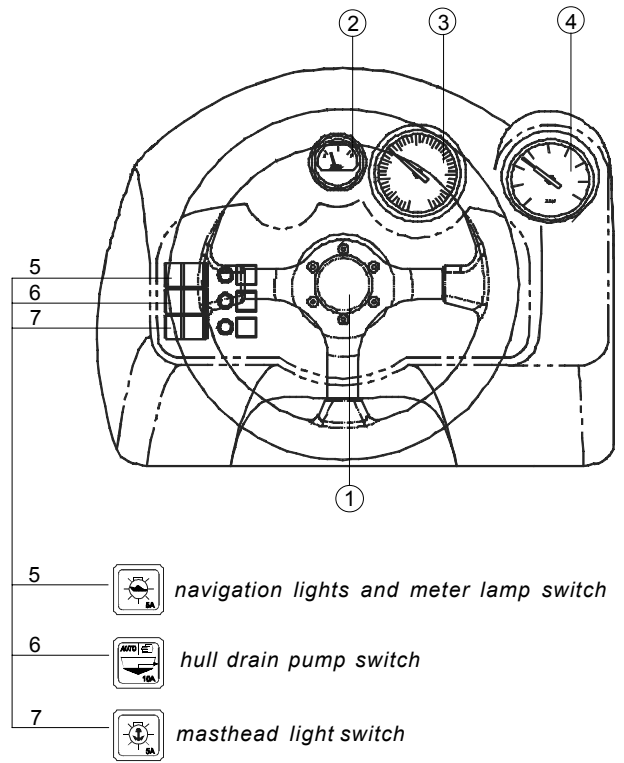

Fig.D6

FUEL SYSTEM.

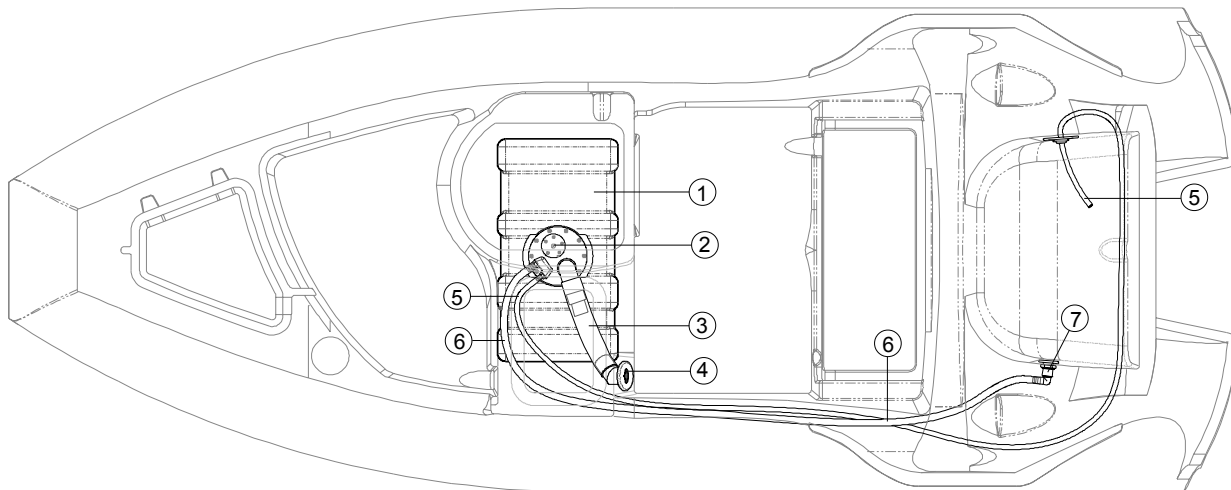

Fig.D7

Fuel system consists of the following components (Fig. D7):

- built-in fuel tank (33L for E340 or 43L for E380) (1);
- electric fuel gauge (2);
- fuel line (from fuel fill to fuel tank) (3);
- fuel fill (4);
- fuel line (from fuel fill to fuel tank) (5);
- drain line (6);
- drain branch pipe (7).



Pre-filter and fuel valve must be installed by authorized representative specialists only.



Do not modify fuel system. Any modification, repair and planned maintenance of the fuel system may be made by authorized representative specialists only.



Check that there are no leaks in the fuel systems



Do not smoke when refueling. Stop the engine and switch off any electric equipments before refueling.

It is dangerous to pretend to be an expert. This may cause damages. Refer to expert and authorized specialists for all types of maintenance and repair.

DRAIN SYSTEM.

Drain system, (Fig. D8), consists of the three inde systems:

- cockpit drain system;
- engine recess drain thru-hull;
- hull drain system.

COCKPIT AND ENGINE RECESS DRAIN SYSTEM

- two cockpit drain sockets with waterproof plug
- two stern drain sockets with flexible diaphragm
- two drain hoses (3);
- engine recess drain thru-hull (4).

HULL DRAIN SYSTEM :

- automatic bilge pump (5);
- drain hose (6);
- bilge pump drain thru-hull mounted in the engine recess (7).
- bilge valve (8).

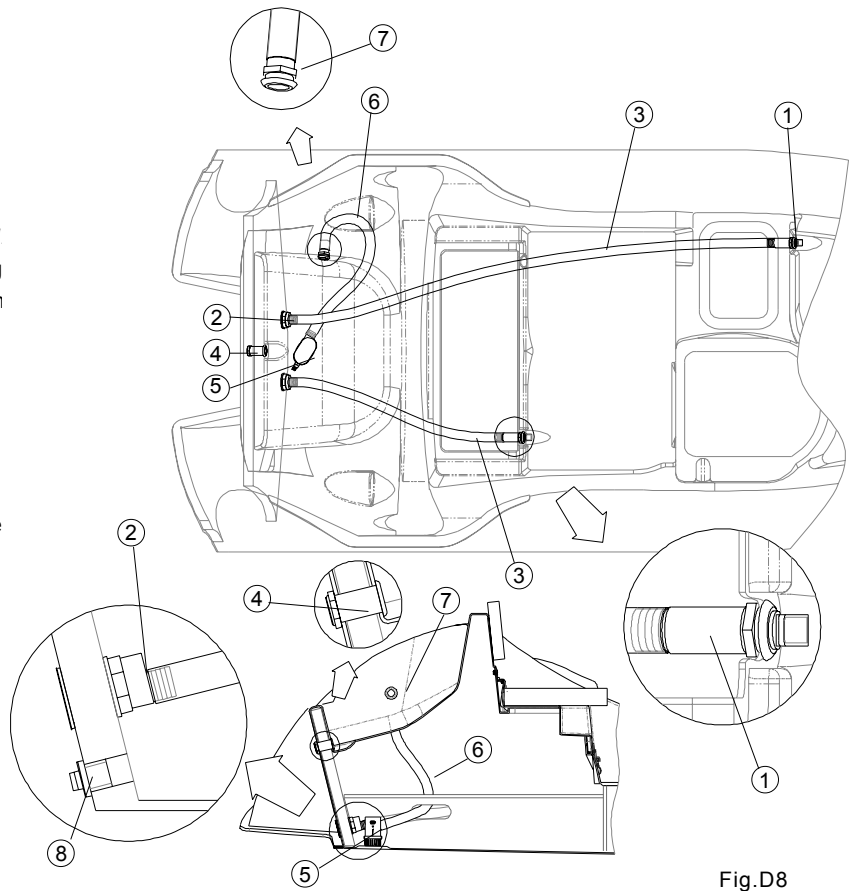







Fig.D8

 WARNING	<p>Always the cockpit drain sockets must be open during navigation. Do not obstruct cockpit drain sockets at any time. Do not dispose bulky objects in front of the cockpit drain sockets.</p>
	<p>Do not modify drain systems. Before navigation check the drain valves.</p>
	<p>Never locate heavy objects on the drain hoses. It will be cause of bucking, distortions and damages.</p>

 WARNING	<p>Bilge valve (8)(Fig.D8) should be tightly CLOSED when the boat on the water</p> <p>Bilge valve (8)(Fig.D8) should be open when the boat is out of the water</p>
---	--

 WARNING	<p>It is dangerous to pretend to be an expert. This may cause damages. Refer to expert and authorized specialists for all types of maintenance and repair.</p>
---	--

 WARNING	<p>Always the cockpit drain sockets must be open during navigation. Do not obstruct cockpit drain sockets at any time. Do not dispose bulky objects in front of the cockpit drain sockets.</p>
---	--

 WARNING	<p>Do not modify drain systems. Before navigation check the drain valves.</p> <p>Never locate heavy objects on the drain hoses. It will be cause of bucking, distortions and damages.</p>
---	---

WIRING DIAGRAM.

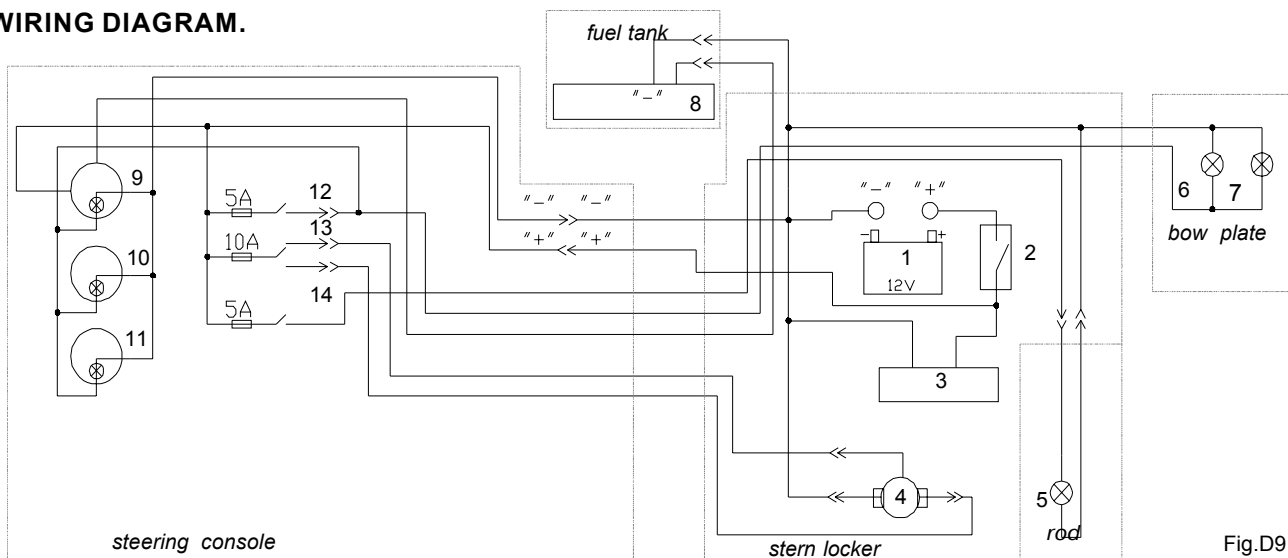



Fig.D9

DESCRIPTION:

- 1 — Battery (provided on the market).
- 2 — Battery disconnecter.
- 3 — Outboard motor (provided on the market).
- 4 — Hull drain pump.
- 5 — Masthead light (white).
- 6 — Port light (red).
- 7 — Starboard light (green).
- 8 — Fuel level gauge.
- 9 — Analog fuel clock.
- 10 — Speedometer.
- 11 — Tachometer.
- 12 — Meter lamp and navigation lights switch with 5A safety device.
- 13 — Hull drain pump "FORCED" / "AUTO" switch with 10A safety device.
- 14 — Masthead light switch with 5A safety device.

 ATTENTION	<p>When leaving the boat, remember to disconnect the batteries.</p>
---	---

 WARNING	<p>Any modification, repair and planned maintenance may be made by authorized representative specialists only.</p> <p>Do not touch the electrical equipment with wet hands.</p>
---	---

ISTORAGE BATTERY INSTALLATION.

In order to install the storage battery, perform next operations:

- open door of the stern compartment;
- install the storage battery into the battery container;
- connect the battery terminals with motor battery cord and battery disconnecter;
- please, check efficiency of the electric equipment.



Before installation your storage battery read the BATTERY MANUAL carefully and ensure that you have understood all the described procedures.

TUBE INFLATION.

Before inflation of compartment it's necessary to set all valves in operating condition. In order to switch valve to operating condition, just press spindle 6 (look before Fig. D3) with your finger and turn it clockwise until it is fixed. If it isn't possible the valve is in operating condition already.

Fill the tube compartments with air using the pump from the complete set. First fill two rear compartments, then bow compartment. Thereat, do not bring the pressure up to its operating value (the tube will be completely straightened).

Then fill the bow compartment with air up to the rated pressure.

The rated pressure value is 0.15 bar (2.2 psi)

On completion of filling close the valves with caps.

In order to discharge air from the compartments, open the valves (just press spindle with your finger and turn it anticlockwise till it is fixed).

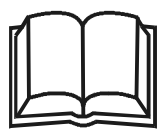

Board air chambers are hermetical if they keep own form during 8 hours. In this case:

- primary pressure has to be nominal;
- input valves openings have to be tightly closed by caps.



Do not use compressors and/or other types of inflating equipments not approved by the boat builder.

Check the tube pressure before every navigation.

The rated pressure value is 0.15 bar (2.2 psi).

If the tube pressure more than nominal, deflate the tube slightly. Boat exploitation with board pressure more than nominal decreases boat service life.

BOAT TRAILERING.

Installed on a trailer (or on keel-blocks for storage) the boat should be laying on all surface of the Basic loading area (keel line) (see Fig. T1).

It is possible to install the boat on several reference points. Thereby the point of support (1) must be an obligatory, and the point of support (2),(3),(4),(5) - must be an additional.

Lateral roller supports can be used only with a view of prevention from tipping.

IT IS FORBIDDEN

In order to avoid the hull damage trail the boat staying on the side areas only.

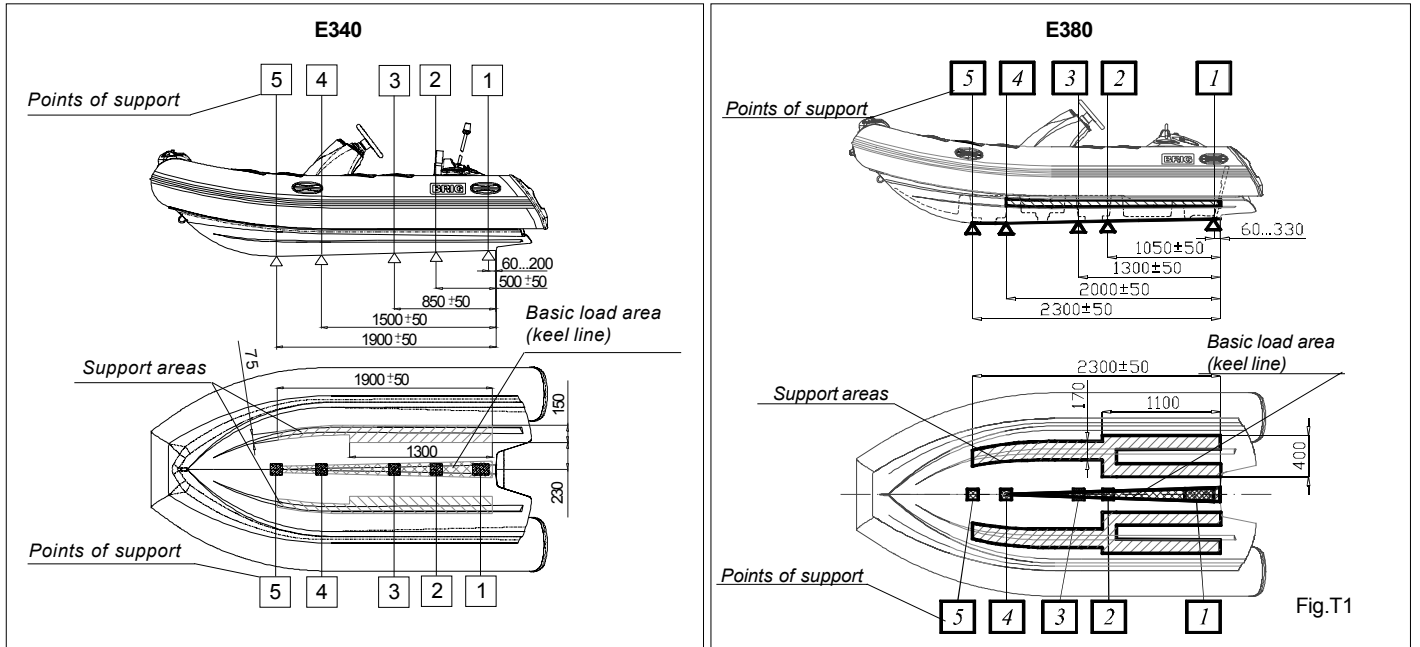

THE MAIN DIMENSIONS.

The main dimensions of E340 and E380 have tolerance of +/- 3%. All dimensions in meters.

The length of the boat with the engine can vary depending on the model of the engine and the angle of its deviation. (See Fig. T2)

	L1 (m)	L2 (m)	H1 (m)	H2 (m)	H3 (m)	B1 (m)
E340	4.05	3.40	1.12	0.91	1.35	1.78
E380	4.55	3.83	1.15	1.00	1.35	1.93

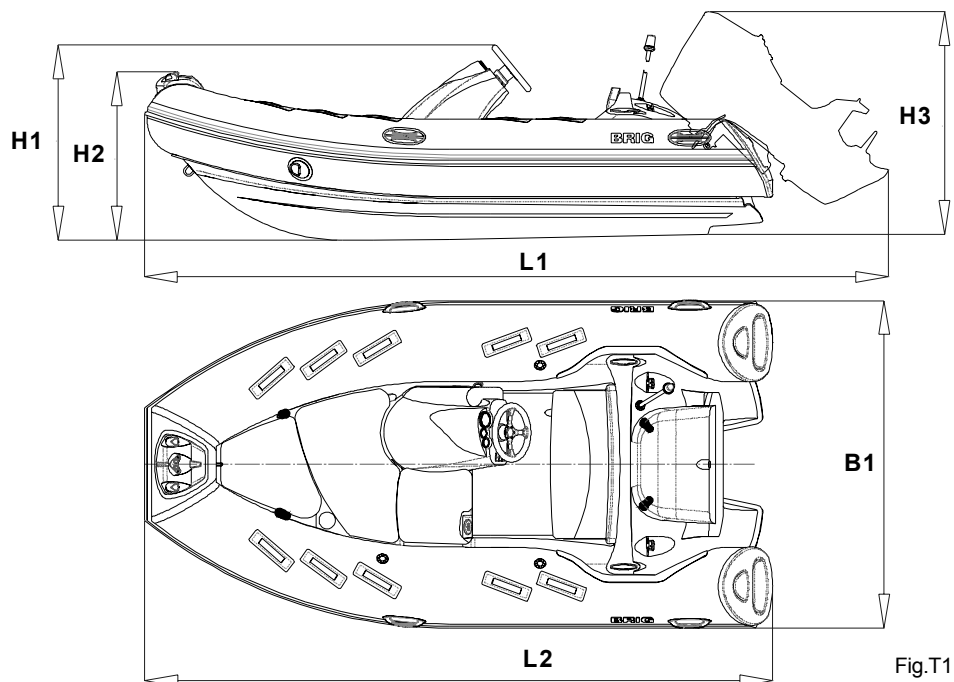

MAINTENANCE.

- Main conditions of long service life is right and careful servicing. Avoid excessive increasing of pressure in the board, especially from heating by the sun rays.
 - At the end of exploitation take off sand and dirt from boat surface, and carefully dry it.
 - Avoid the water getting into the chambers. If a fuel or an oil gets to the boat surface it is necessary to wash the soiled place by soap water as soon as possible and dry.
 - Pay attention to the condition of bottom surfaces. If the cover is destroyed it is necessary to dry this element and restore the defend cover.
 - At the end of the season exploitation, prepare the boat to winter keeping. Clean boat surface from sand and dirt, and make the necessary repairs, if damages take place. If it is possible, keep the boat in open and slightly pumped state at air temperature 0-25°C. The boat must be protected from the sun rays.
 - Insignificant boat repairing (eliminating the board punctures or cuts) you may carry out by yourself. In this case use the coated fabric and glue set for repair from the complete set.
- The own fulfilment of any complex repair associated with considerable damages to the board, partitions and seams is not recommended. In such cases, apply to your dealer.

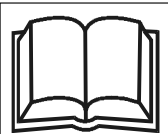

ATTENTION





Storage of the boat with temperature variations from -30°C to +45°C may be allowed not longer than 1 month. In case the boat has been stored or transported at a temperature below 0°C, it must be kept at a temperature above +15°C at least for 1 hour before to be unpacked and unfolded.





For small repair boat tube use the coated fabric and glue set from the complete set.

OPERATING REGULATIONS.

Dear user,

We thank you for your purchase and do hope that you will have a great fun of it. However, to make your joy and pleasure complete, we would request you to read carefully and observe the directions and recommendations specified below.

 <p>DANGER</p>	<p>IT IS STRICTLY FORBIDDEN to handle the boat in the state of intoxication and without individual rescue means being used (life-saving belts, jackets, etc.)</p>
	<p>IT IS FORBIDDEN to use an outboard motor of power exceeding the maximum allowable value</p>
 <p>WARNING</p>	<p>IT IS FORBIDDEN to bring the tube pressure up to the value exceeding the rated one (0.15 bar(2.2psi))</p>
	<p>IT IS STRICTLY FORBIDDEN to drag the boat across a rough surface.</p>
	<p>For each particular water area the local shipping regulations are in force. You may apply for information to the appropriate water transport and shipping directorate, as well as to the water police.</p>
 <p>WARNING</p>	<p>Use the boat equipment and accessories only on their direct purpose to ensure reliable service.</p>
	<p>Even when sailing with an outboard engine you should always have the oars available with you so that you were able to reach the shore without outside assistance in case of any damage of the boat.</p>
 <p>WARNING</p>	<p>On your request any outboard engine seller may provide your engine with the emergency stop switch. During navigation the switch should be connected to the wrist of your hand by means of a cord. In case you fall overboard, even if being a steersman, the switch will cut out the engine and the propeller. This arrangement will enable you to avoid any traumas and to reach the boat.</p>
	<p>Take all possible precautions against penetration of fuel, oil or electrolyte from the storage battery into the inflatable boat. If it does happen wash thoroughly the fouled spots with water.</p>

 <p>DANGER</p>	<p>You should be always sure that the number of people on board never exceeds that specified in the owner's manual or on the builder's plate provided on the transom.</p> <p>The boat will retain an adequate floatability and will not keel over only provided that the load is arranged reasonably. Therefore, do not accommodate all passengers on the same side of the boat.</p>
 <p>DANGER</p>	<p>All passengers should be accommodated inside the boat. The occupied seats should not be left throughout the entire sailing time.</p>
 <p>DANGER</p>	<p>All passengers should put on life-saving jackets.</p> <p>CHILDREN and non-swimmers MUST WEAR A FLOATATION DEVICE AT ALL TIMES.</p> <p>Always check that floatation devices for children are of the right size and that they are operational.</p>
 <p>DANGER</p>	<p>Arrange the cargo to be carried uniformly inside the boat, all items being reliable secured on the bottom of the boat.</p> <p>When sailing with an outboard engine the steersman should shift his body forward in the course of acceleration to prevent the boat forebody from raising under the force of upthrust waves.</p>
 <p>WARNING</p>	<p>Despite the strong shell of the boat we recommend carefully handle and operate with sharp and pricking objects which you have on board . It concerns, for example, a knife blade, fish-hook point, etc.</p>



Approaching to rocky shores, shoals, moles, etc. , please be careful to avoid damages of your boat. It is strictly prohibited to drag the boat across rough surfaces (shingle, rocks, concrete, etc.).

In case of prolonged navigation with the use of an outboard motor, regularly check, that the motor is reliably attached to the boat. If the engine was attached carelessly, the attachment may loosen under the action of vibration.



Besides, at regular intervals, please check air chambers pressure , since the pressure may vary under the effects of outside air temperature and atmospheric pressure variations.

Never forget to monitor regularly the quantity of fuel in the fuel tank. Keep always in mind that the quantity of fuel should be sufficient for you to sail to your final destination.

● Towing



At towing the towing rope length should not be less at least 3 lengths of the boat.

The steersman of the towed boat should be assisted by another crew member to monitor the process of towing. In this case, certain communication gestures should be agreed upon beforehand.



The rope have to be attached to both boats in a manner ensuring its immediately, single-motion release.

● Damage to one of air chambers

The inflatable boat is designed to provide an adequate stability in case of the complete damage to one of the air chambers (balloon compartments) at the expense of the remaining air chambers and the hull. Thanks to it, you will be able to reach safely the nearest shore. Reduce the speed and shift your body to the undamaged part of the boat. Observe changes in stability. After that, immediately head for the nearest shore. To prevent penetration of water into the boat, pull the shell of the damaged air chambers upwards.

● **Mooring fast fastening**



Attach towing rope in the bow of the boat to the one of the frontal towing rings. Attach bow mooring ropes to the bow mooring cleats only. Attach rear mooring ropes or the rope of back anchor to the rear mooring cleats only.

● **Danger of currents and wind**



Before begin navigation on the boat, make detail inquiries about local conditions and regulations! Currents, wind, shoals, rising and falling tides, as well as weather variations may imply serious danger!

● **In emergency stay in boat**

In any unexpected situation (engine failure, boat damage, etc.), never leave the boat, if it is still afloat. Even if you believe that the shore is just nearby, stay in the boat, since you will be looked for in this particular place and, most probably, will be found. Should the boat become partially flooded, throw heavy objects (batteries, fuel tank, engine) overboard to ensure additional floatability.

● **Handling under power**



Manoeuvrability above 15knots (25 km/h) is limited. Sudden turn may cause loss of control. Reduce speed before sharp turn, in either direction.



When the boat is fitted with an engine with maximum recommended power it must be use with extreme care. This application is directed at experienced users using their boats for very specific purposes.



Do not operate your boat with an engine of rated power larger than that stated on the builder's plate in the boat.

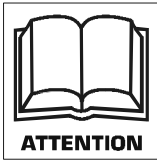

Do not operate this craft at negative propulsion unit trim settings (bow down) at high speed. Craft may lean over on side. Instability in turns may result. Use negative trim to accelerate to planing speed from displacement speed and at lower planing speeds in choppy water (applicable to craft equipped with propulsion unit power trim).

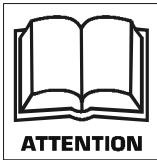

Do not operate at maximum speed while in congested high traffic waterways or in weather and sea conditions of reduced visibility high winds or large waves. Reduce speed and wake as a courtesy and as a safety consideration to yourself and others. Observe and obey speed limit and no wake zones.

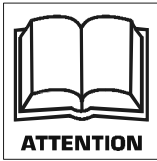

Observe right-of-way as defined by Rules of the Road and required by COLREG.

Always be certain to have sufficient distance to stop or manoeuvre if required to avoid collisions.

